

Encoder A449/001

OrderNo.:41449002-01250
8.10.2019 / 0

Technical data

Pulse-rate	1250
Channels	A,A/,B,B/,N,N/
Signals	square wave
Supply voltage	5V
Output voltage	5V
Output frequency	300kHz
Cable/Connector entry	side cable
Cable length	220mm
Pin assignment	ST9834
Shaft design	Konus
Enclosure rating	IP60
Limit temperature	0/+80°C
Shaft load axial	10N
Shaft load radial	20N
DRAWING NO.	41-449-002-

GL	Wellenausführung glatt / shaft type cylindrical
FL	Wellenausführung mit Fläche / shaft type with flat surface
N	Wellenausführung mit Nut / shaft type with slot
Hohlw	Hohlwelle / hollow shaft
Klemme	mit Klemmring / with clamping ring
Grundw	Grundwelle / fundamental shaft
SLG	Seillängengeber / cable retractor
ZB	Zentrierbund / centre ring
Tachofl	Tachoflansch / tachometer flange
DAG	DAG-Schutzgehäuse / DAG protective housing
TK	Teilkreis / pitch circle

Subject to change.

Mechanische Abmessungen für Gebertyp AMI
Mechanical dimensions encoder-type AMI
A449/001 (41449002-XXXXX)

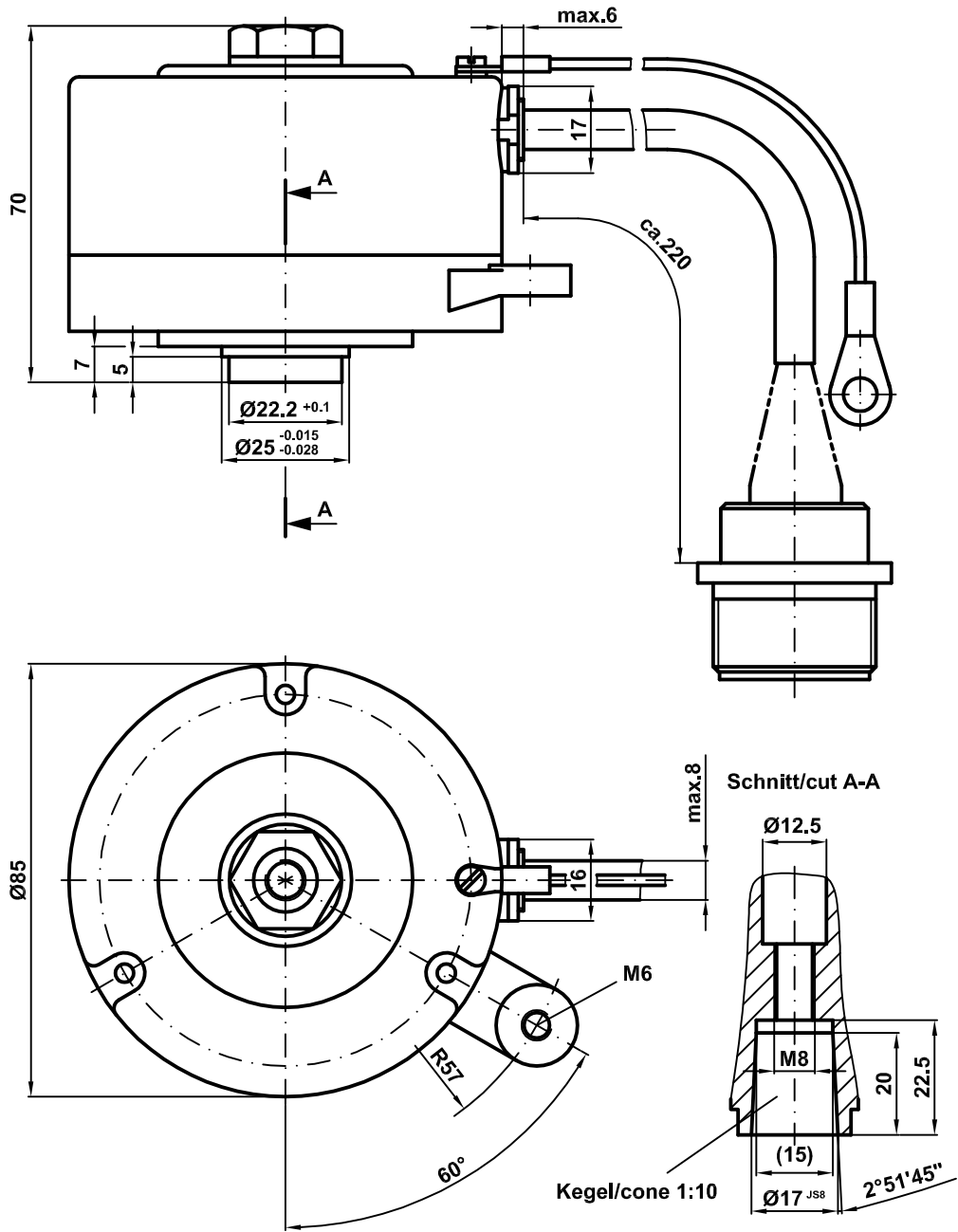

Pin assignment

Pin assignment number: 9834

Index:

23.01.2014

Connector name: 17-pol AMPHENOL

Pin-count: 17

Page: 1/1

Pin	Designation	Description	Level	Driver	NC	Colour
A	CH_A_OUT	Channel A	5V	RS 422		brown
B	CH_B_OUT	Channel B	5V	RS 422		gray
C	Supply Voltage IN	Supply voltage	5V			brown 0,5
D	/CH_A_OUT	Channel A inverted	5V	RS 422		green
E	/CH_B_OUT	Channel B inverted	5V	RS 422		pink
F	CH_I_OUT	Channel Reference	5V	RS 422		red
G	/CH_I_OUT	Channel Reference inverted	5V	RS 422		black
H	Screen	Shield				transparency
J	Supply Voltage IN	Supply voltage	5V			blue
K	Supply Voltage IN	Supply voltage	5V			(bridge)
L	not connected					
M	not connected					
N	Ground IN	Ground	0V			white 0,5
P	Ground IN	Ground	0V			white
R	Bridge R-S					
S	Bridge R-S					
T	Ground IN	Ground	0V			(bridge)

WARNING

'De-energize the system before carrying out wiring work or opening and closing electrical connections !

Short-circuits, voltage peaks, etc. can cause operating failures and uncontrolled operating states, as well as serious personal injuries and damage to property.

Verdrahtungsarbeiten, Öffnen und Schließen von elektrischen Verbindungen nur im spannungslosen Zustand durchführen ! Kurzschlüsse, Spannungsspitzen etc. können zur Fehlfunktion und unkontrollierten Zuständen der Anlage bzw. zu erheblichen Personen- und Sachschäden führen.