

Encoder A449/001

OrderNo.:41449003-02500
8.10.2019 / 0

Technical data

| | |
|-----------------------|----------------|
| Pulse-rate | 2500 |
| Channels | A,A/,B,B/,N,N/ |
| Signals | square wave |
| Supply voltage | 5V |
| Output voltage | 5V |
| Output frequency | 300kHz |
| Cable/Connector entry | side cable |
| Cable length | 220mm |
| Pin assignment | ST9834 |
| Shaft design | Konus |
| Enclosure rating | IP60 |
| Limit temperature | 0/+80°C |
| Shaft load axial | 10N |
| Shaft load radial | 20N |
| DRAWING NO. | 41-449-003- |

| | |
|----------------|--|
| GL | Wellenausführung glatt / shaft type cylindrical |
| FL | Wellenausführung mit Fläche / shaft type with flat surface |
| N | Wellenausführung mit Nut / shaft type with slot |
| Hohlw | Hohlwelle / hollow shaft |
| Klemme | mit Klemmring / with clamping ring |
| Grundw | Grundwelle / fundamental shaft |
| SLG | Seillängengeber / cable retractor |
| ZB | Zentrierbund / centre ring |
| Tachofl | Tachoflansch / tachometer flange |
| DAG | DAG-Schutzgehäuse / DAG protective housing |
| TK | Teilkreis / pitch circle |

Subject to change.

Mechanische Abmessungen für Gebertyp AMI
Mechanical dimensions encoder-type AMI
A449/001 (41449003-XXXXX)

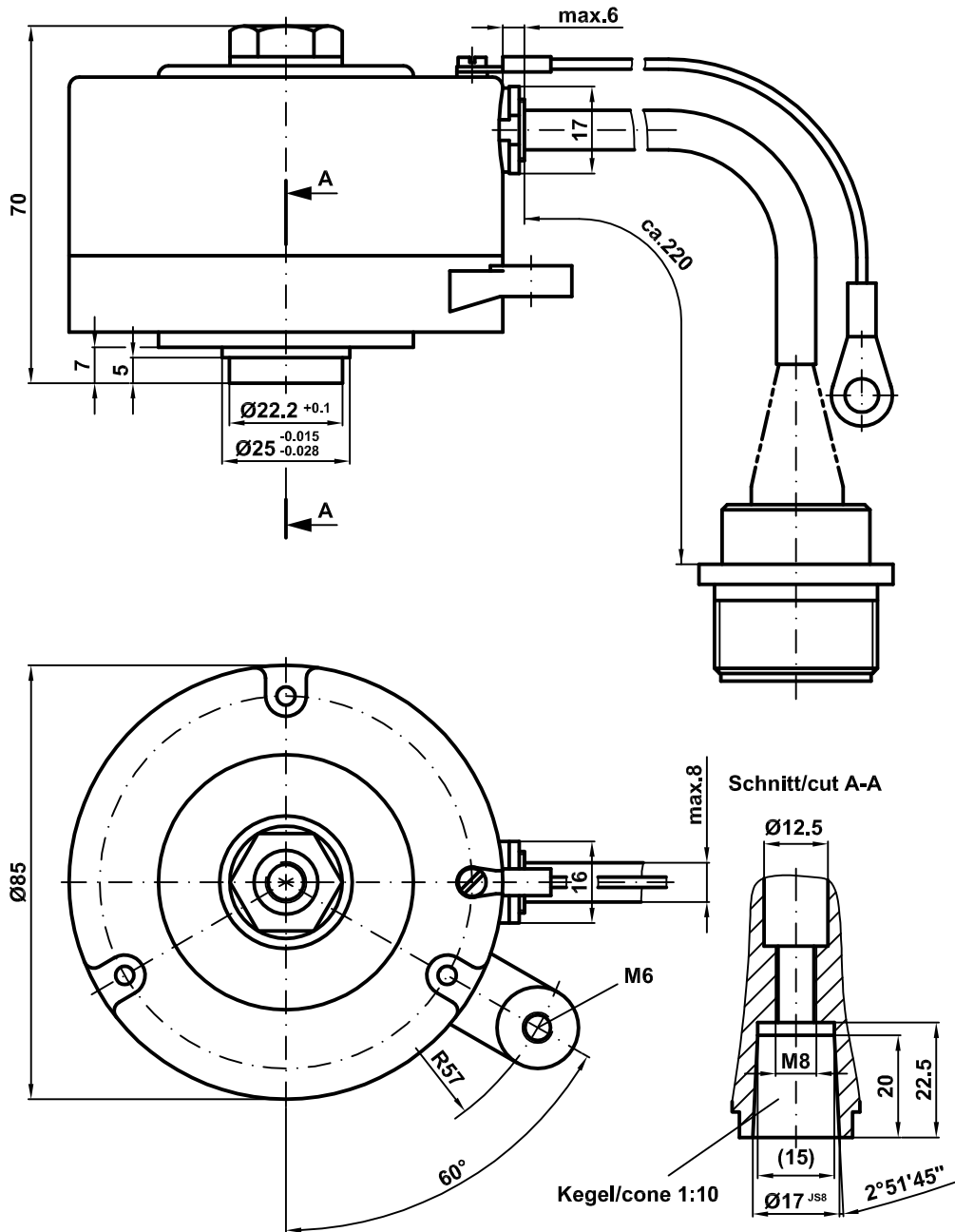

Pin assignment

Pin assignment number: 9834

Index:

23.01.2014

Connector name: 17-pol AMPHENOL

Pin-count: 17

Page: 1/1

| Pin | Designation | Description | Level | Driver | NC | Colour |
|-----|-------------------|----------------------------|-------|--------|----|--------------|
| A | CH_A_OUT | Channel A | 5V | RS 422 | | brown |
| B | CH_B_OUT | Channel B | 5V | RS 422 | | gray |
| C | Supply Voltage IN | Supply voltage | 5V | | | brown 0,5 |
| D | /CH_A_OUT | Channel A inverted | 5V | RS 422 | | green |
| E | /CH_B_OUT | Channel B inverted | 5V | RS 422 | | pink |
| F | CH_I_OUT | Channel Reference | 5V | RS 422 | | red |
| G | /CH_I_OUT | Channel Reference inverted | 5V | RS 422 | | black |
| H | Screen | Shield | | | | transparency |
| J | Supply Voltage IN | Supply voltage | 5V | | | blue |
| K | Supply Voltage IN | Supply voltage | 5V | | | (bridge) |
| L | not connected | | | | | |
| M | not connected | | | | | |
| N | Ground IN | Ground | 0V | | | white 0,5 |
| P | Ground IN | Ground | 0V | | | white |
| R | Bridge R-S | | | | | |
| S | Bridge R-S | | | | | |
| T | Ground IN | Ground | 0V | | | (bridge) |

WARNING

'De-energize the system before carrying out wiring work or opening and closing electrical connections !

Short-circuits, voltage peaks, etc. can cause operating failures and uncontrolled operating states, as well as serious personal injuries and damage to property.

Verdrahtungsarbeiten, Öffnen und Schließen von elektrischen Verbindungen nur im spannungslosen Zustand durchführen ! Kurzschlüsse, Spannungsspitzen etc. können zur Fehlfunktion und unkontrollierten Zuständen der Anlage bzw. zu erheblichen Personen- und Sachschäden führen.