

Encoder B100/079

OrderNo.:41100340-01000
7.10.2019 / 0

Technical data

Pulse-rate	1000
Channels	A,A/,B,B/,N,N/
Signals	square wave
Supply voltage	10-30V
Output voltage	10-30V
Output frequency	300kHz
Cable/Connector entry	axial
Pin assignment	ST9812
Shaft design	6Glatt/10
Enclosure rating	IP64 on shaft
Limit temperature	0/+80°C
Shaft load axial	10N
Shaft load radial	20N
Current (unloaded)	max. 120mA
DRAWING NO.	41-100-340-

GL	Wellenausführung glatt / shaft type cylindrical
FL	Wellenausführung mit Fläche / shaft type with flat surface
N	Wellenausführung mit Nut / shaft type with slot
Hohlw	Hohlwelle / hollow shaft
Klemme	mit Klemmring / with clamping ring
Grundw	Grundwelle / fundamental shaft
SLG	Seillängengeber / cable retractor
ZB	Zentrierbund / centre ring
Tachofl	Tachoflansch / tachometer flange
DAG	DAG-Schutzgehäuse / DAG protective housing
TK	Teilkreis / pitch circle

Subject to change.

Mechanische Abmessungen für Gebertyp AMI
Mechanical dimensions encoder-type AMI
B100/079 (41100340-XXXXX)

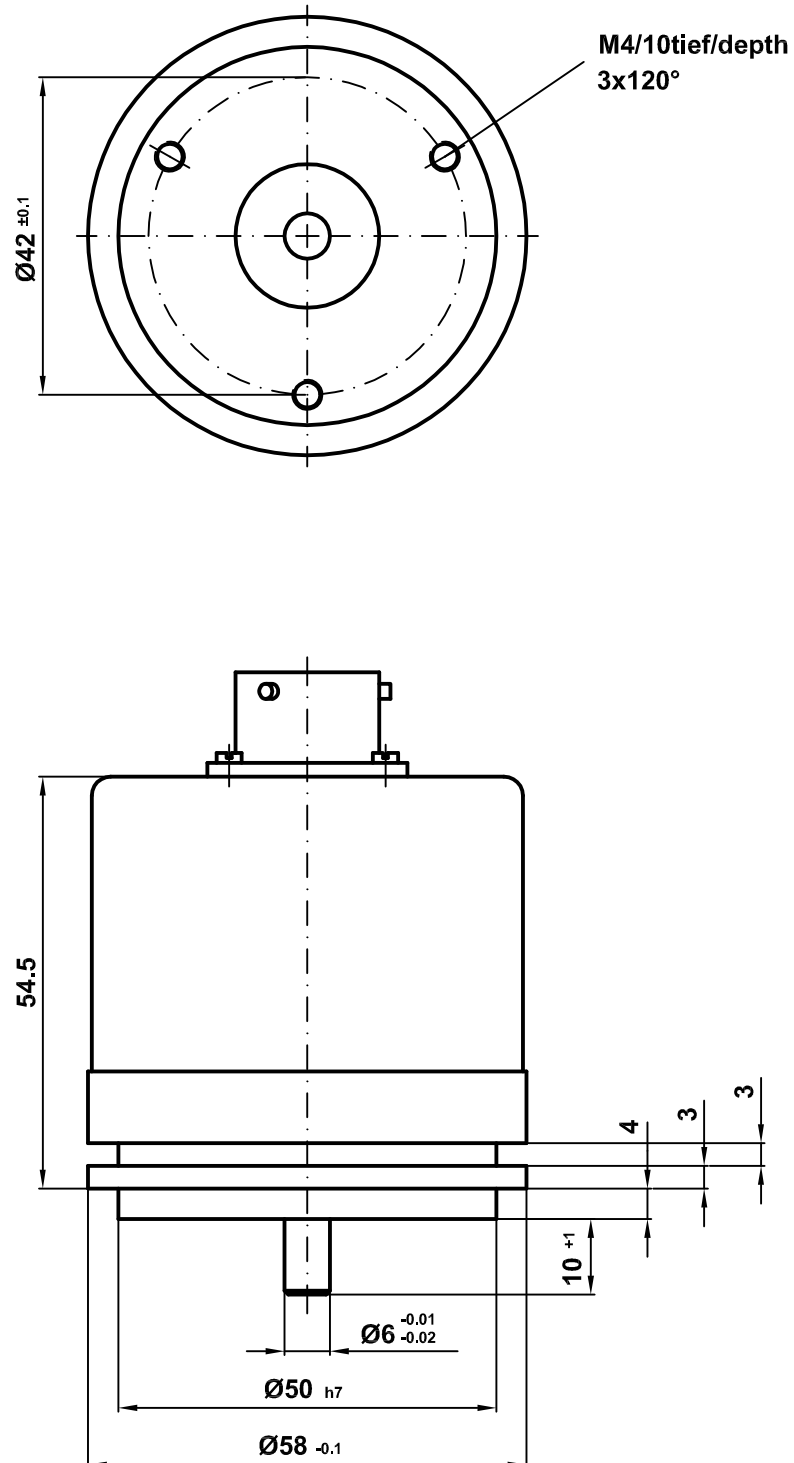

Pin assignment

Pin assignment number: 9812

Index:

03.09.2014

Connector name: 8-pol KPT

Pin-count: 8

Page: 1/1

Pin	Designation	Description	Level	Driver	NC	Colour
A	CH_B_OUT	Channel B	10-30V	Push Pull		gray
B	/CH_B_OUT	Channel B inverted	10-30V	Push Pull		pink
C	/CH_A_OUT	Channel A inverted	10-30V	Push Pull		green
D	CH_A_OUT	Channel A	10-30V	Push Pull		brown
E	Supply Voltage IN	Supply voltage	10-30V			blue
F	Ground IN	Ground	0V			white
G	CH_I_OUT	Channel Reference	10-30V	Push Pull		red
H	/CH_I_OUT	Channel Reference inverted	10-30V	Push Pull		black

WARNING

'De-energize the system before carrying out wiring work or opening and closing electrical connections !

Short-circuits, voltage peaks, etc. can cause operating failures and uncontrolled operating states, as well as serious personal injuries and damage to property.

Verdrahtungsarbeiten, Öffnen und Schließen von elektrischen Verbindungen nur im spannungslosen Zustand durchführen ! Kurzschlüsse, Spannungsspitzen etc. können zur Fehlfunktion und unkontrollierten Zuständen der Anlage bzw. zu erheblichen Personen- und Sachschäden führen.